

De'Longhi De'Longhi SpA
TREVISO-ITALIA
Made in Italy
CAT:MA TYP:EAM3 __.S EX:--
220-240V - 50/60Hz
SER. NR.:
S02

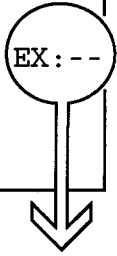

CONTROLLARE L'ETICHETTA
CHECK THE LABEL

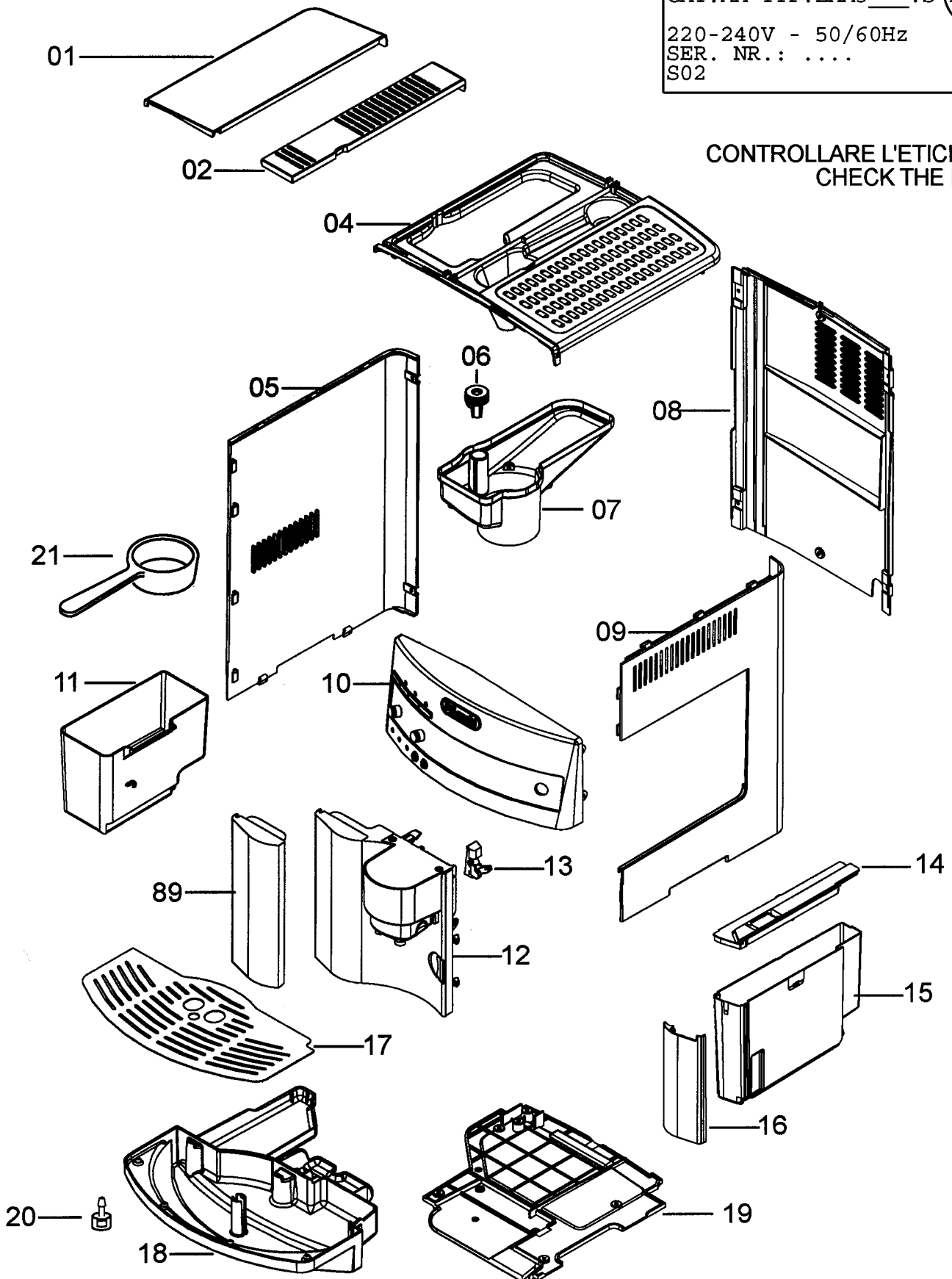

**ETICHETTA
COLLAUDO**
TEST LABEL

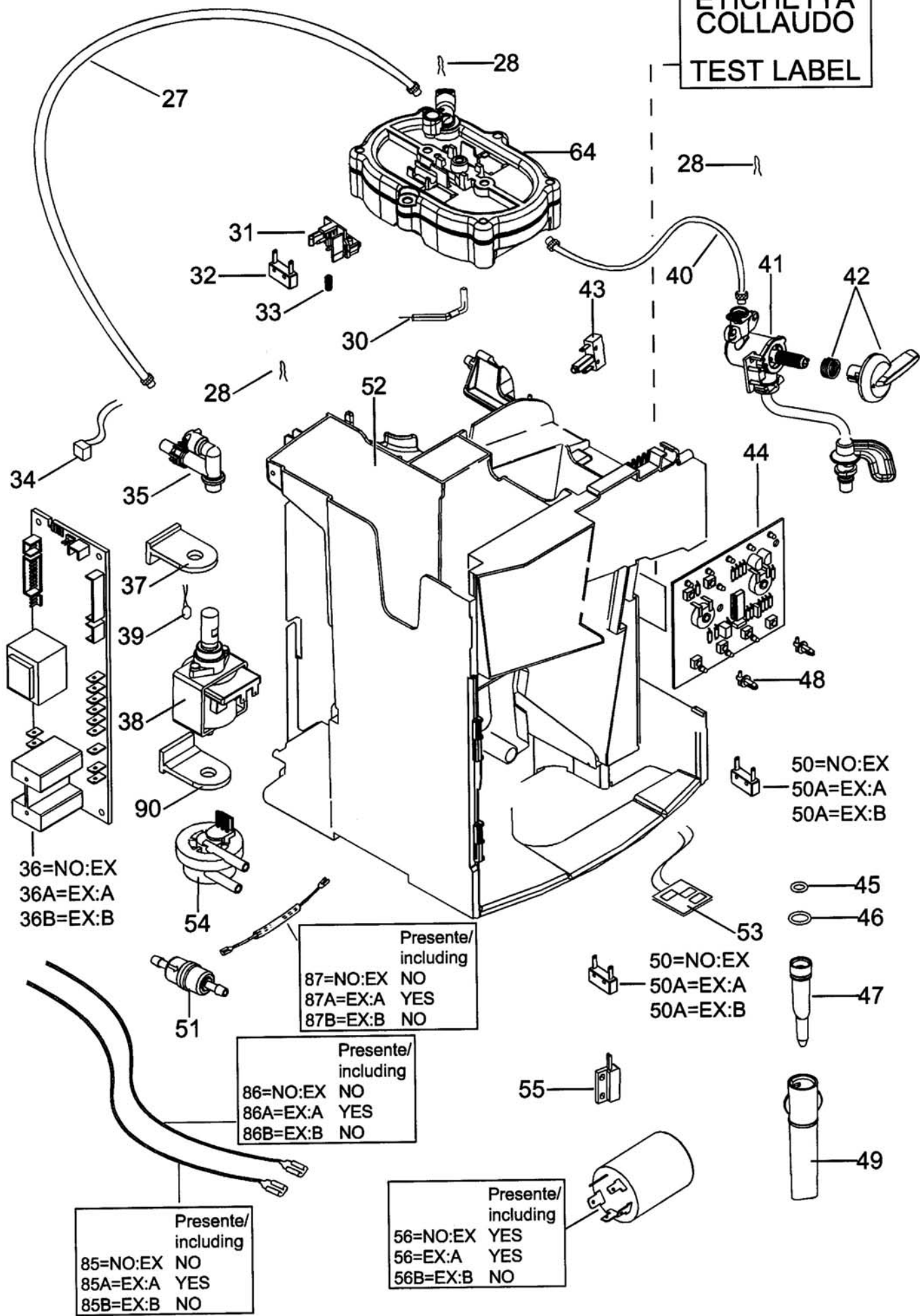

Presente/ including	
85=NO:EX	NO
85A=EX:A	YES
85B=EX:B	NO

Presente/ including	
86=NO:EX	NO
86A=EX:A	YES
86B=EX:B	NO

Presente/ including	
87=NO:EX	NO
87A=EX:A	YES
87B=EX:B	NO

Presente/ including	
56=NO:EX	YES
56=EX:A	YES
56B=EX:B	NO

50=NO:EX
50A=EX:A
50A=EX:B

50=NO:EX
50A=EX:A
50A=EX:B

45
46

47

49

55

53

48

44

41

42

40

43

64

28

27

31

32

33

30

28

52

35

37

39

38

90

54

51

34

36=NO:EX
36A=EX:A
36B=EX:B

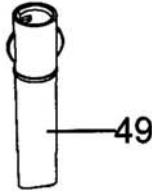
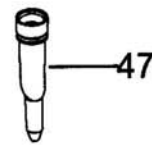
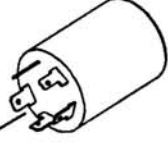
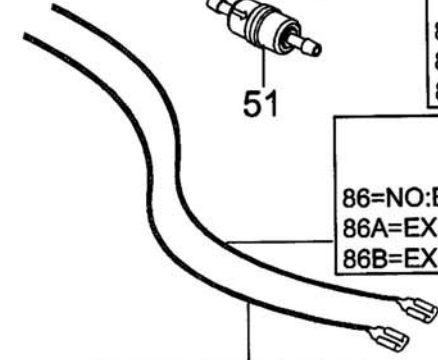
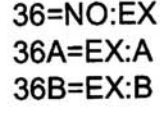
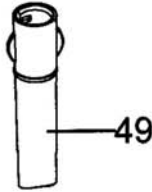
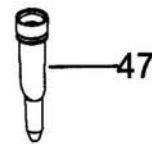
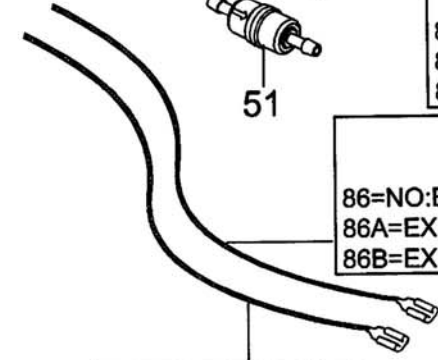
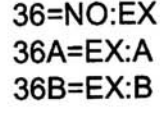
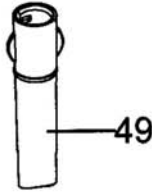
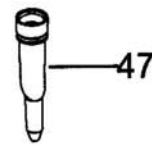
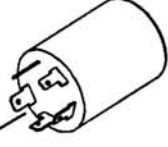
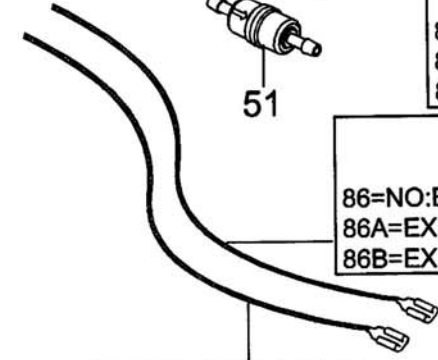
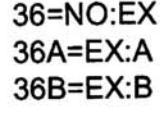
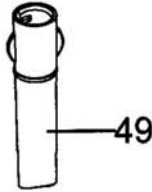
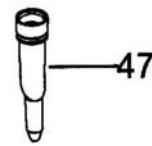
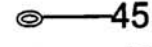
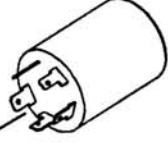
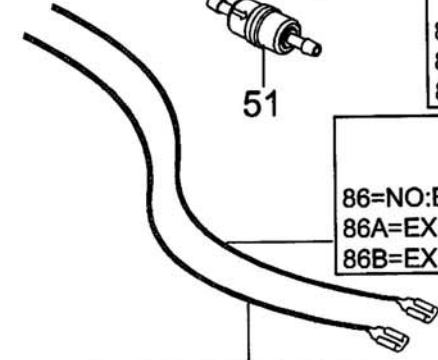
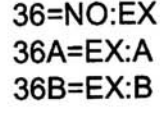
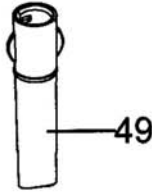
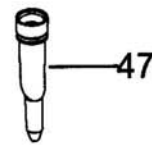
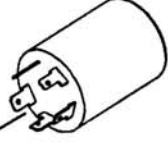
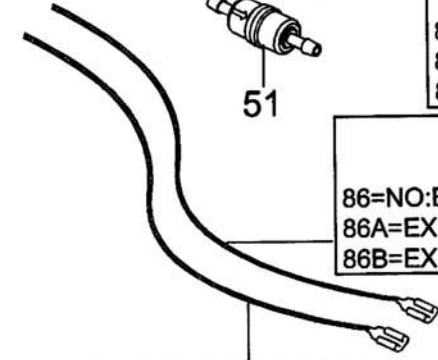
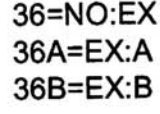
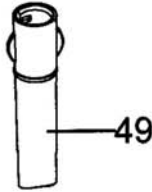
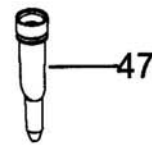
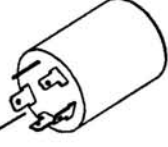
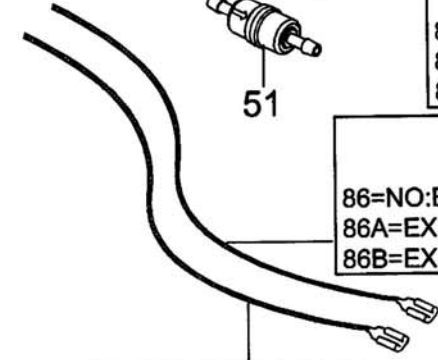

ETICHETTA
COLLAUDO
TEST LABEL

CCCC **EE** SSSSS PPPP

**PER ORDINARE CONTROLLARE L'ETICHETTA
← TO PLACE AN ORDER CHECK THE LABEL**

**AA=62
AB=62B**

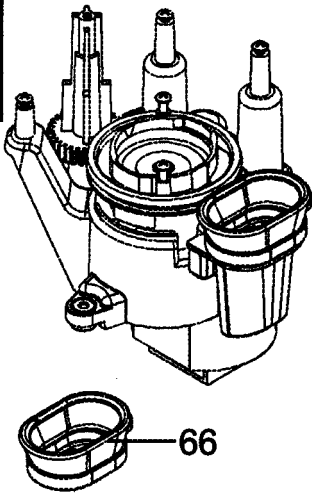

64

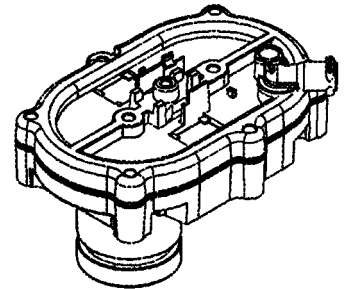

67

74

63

65

63

63

69

70

68=NO:EX
68=EXA
68B=EX:B

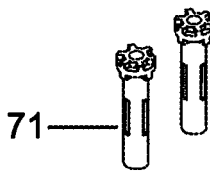

72

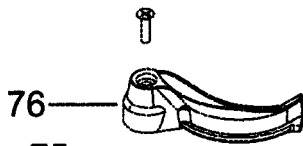

75

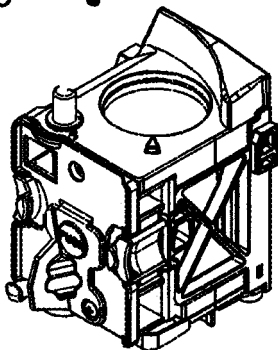

78

79

80

81

82

83

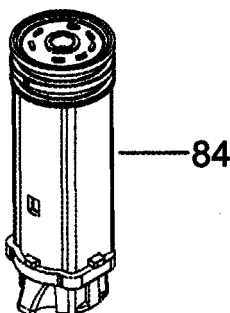

84

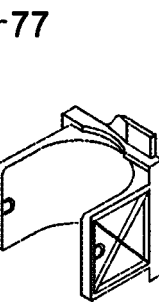

91

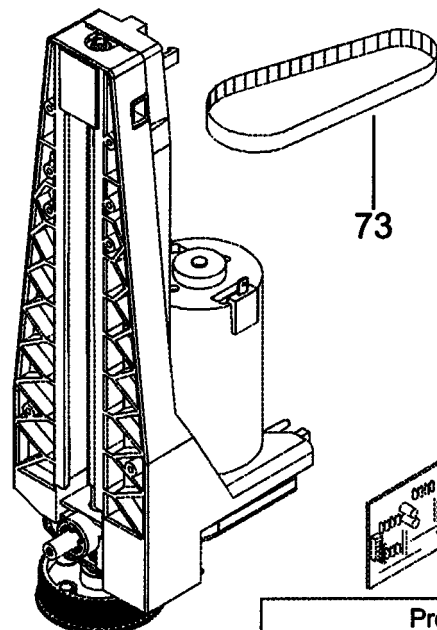

73

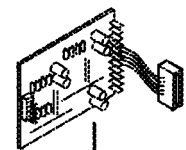

Presente/
including

88=NO:EX NO
88A=EX:A NO
88B=EX:B YES

DE'LONGHI

EAM 3200.S MAGNIFICA SILVER

RU SA INT SKA EAM3200.S

Pos.	Code	Description
	7313217261	MOTOR ASSEMBLY
	5313210401	COVER-SAVE FINGERS B BLACK
	5332224100	BELT
01	5332143500	COVER
02	5332143400	COVER
04	7313224511	CLOSURE
05	5332143900	SIDE LEFT
06	5913210471	KNOB
07	5532146600	TANK
08	5332168900	REAR PANEL
09	5332143800	SIDE RIGHT
10	7332172100	CONTROL PANEL ASSEMBLY
11	VI000	SEE TECHNICAL INFORMATION
12	7313220621	DOOR ASSY
13	5332142600	HOOK
14	5332145600	COVER
15	7313228241	TANK
16	5332151700	PROFILE
17	6032105000	CUP PLATE
18	5332144200	TRAY
19	5332225800	BOTTOM
20	5332266300	FLOAT
21	5332169200	MEASURING SPOON
27	5532118000	TUBE PTFE DI2-DE4 L=230 2BUSHES
28	6132101300	CLIP
30	5032513900	TCO
31	5332142200	SUPPORT
32	5132104100	MICROSWITCH
33	6132104700	SPRING
34	5217100200	SENSOR NTC
35	7313219431	VALVE
36B	5232109400	POWER BOARD
36A	5232105200	POWER BOARD
36	5232102900	POWER BOARD
37	5332159800	SUPPORT
38	5113211281	PUMP
39	5232103200	PROTECTOR

DE'LONGHI

EAM 3200.S MAGNIFICA SILVER

RU SA INT SKA EAM3200.S

40	5513213761	TUBE PTFE DI2-DE4 L=190 2BUSHES
41	7313216621	TAP
42	5513222451	KNOB
43	5113210421	MICROSWITCH
44	5232110000	CONTROL BOARD 11 PIN
45	5313217761	O-RING
46	533135	O-RING
47	5332113800	TUBE LOWER
48	5332146600	EXTENSION
49	5332229600	COVER
50A	5132105400	MICROSWITCH
50	5113210421	MICROSWITCH
51	5513220521	FILTER
52	VI000	SEE TECHNICAL INFORMATION
53	5213213971	HALL SENSOR
54	5213214671	FLOWMETER
55	5232104600	SENSOR REED
56	5132105000	FUSE
56	5132104600	NOISE FILTER
62	IT0087	SEE TECHNICAL INFORMATION
62B	7332203600	COMPLETE GRINDER
63	5313217751	O-RING
64	7332182500	GENERATOR
65	5332142700	PIN
66	5332144900	GASKET
67	5332139200	FILTER
68	7313226111	TRANSMISSION KIT
68B	7313226111	TRANSMISSION KIT
69	5332148400	VALVE
70	6132106900	SPRING
71	5332142300	BUSH
72	5332142400	BUSH
73	5332170600	BELT
74	5332149100	O-RING
75	6132103500	SPRING
76	5332139800	LEVER
77	7332183900	DIFFUSER KIT
78	9812631250	SCREW

DE'LONGHI

EAM 3200.S MAGNIFICA SILVER

RU SA INT SKA EAM3200.S

79	6032105300	FILTER
80	5332149100	O-RING
81	5332139600	STOPPER
82	5332139500	VALVE
83	6132106700	SPRING
84	5332140300	PISTON
85A	5032515900	HEATING Element GREEN CABLE
86A	ES000	*NOT AVAILABLE
87	5132105000	FUSE
88B	5213212381	MOTOR BOARD
89	5332151600	COVER
90	534848	SUPPORT
91	7332166600	SLIDER